

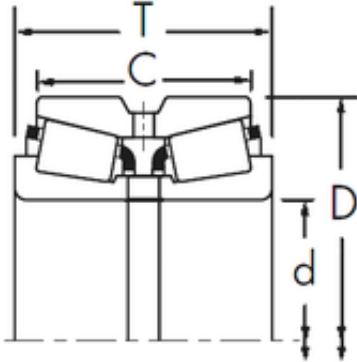

NTN Bearing Driveshaft do Brasil

Timken 24118/24262D+X1S-24118 tapered roller bearings

Bearing No. 24118/24262D+X1S-24118



24118/24262D+X1S-24118 Bearing 2D drawings and 3D CAD models

Size	30.162x66.421x44.453 mm
Bore Diameter	30,162 mm
Outer Diameter	66,421 mm
Width	44,453 mm
d	30,162 mm
D	66,421 mm
T	44,453 mm
C	38,1 mm
R	1,5 mm
r	0,8 mm