

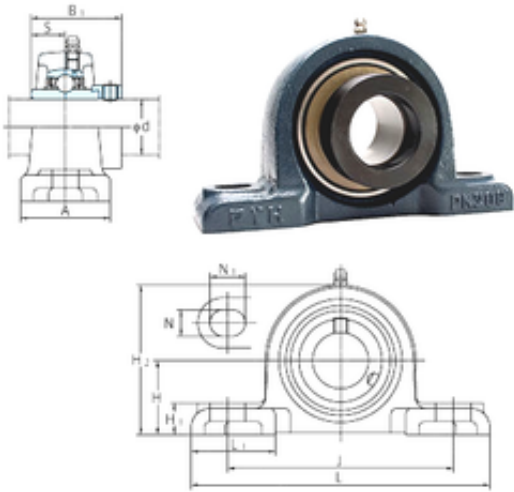

NTN Bearing Driveshaft do Brasil



FYH NAPK211-35 bearing units

Bearing No. NAPK211-35

Bore Diameter	55,5625 mm
d	55,5625 mm
H	61,9 mm
A	60 mm
B1	71,4 mm
H1	25 mm
H2	124 mm
J	181 mm
L	232 mm
L1	66 mm
N	18 mm
N1	24 mm
S	27,8 mm
Bolt (G)	5/8
Weight	4,6 Kg
Basic dynamic load rating (C)	43,4 kN
Basic static load rating (C0)	29,4 kN

NAPK211-35 Bearing 2D drawings and 3D CAD models