

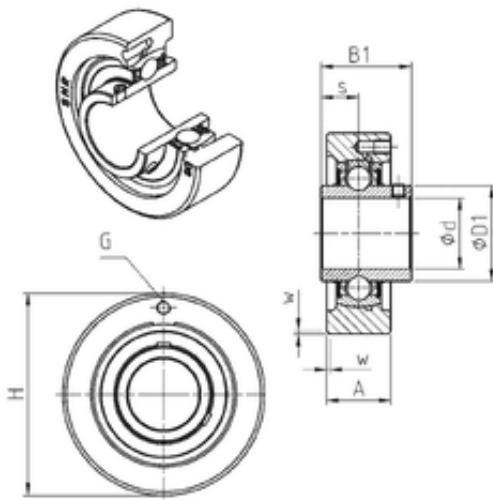

NTN Bearing Driveshaft do Brasil



UCC322 Bearing 2D drawings and 3D CAD models

SNR UCC322 bearing units

Bearing No. UCC322

Bore Diameter	110 mm
d	110 mm
s	46 mm
A	80 mm
B1	117 mm
D1	149 mm
H	300 mm
W	5 mm
Thread (G)	M10x1
Weight	28,3 Kg
Basic dynamic load rating (C)	205 kN
B	117 mm
A3	5 mm
A5	71 mm
G	M10x1
s1	58.5 mm
S	46 mm
SW	9 mm
C	205 kN
C0	178 kN
T min.	-20 ° C
T max.	100 ° C
Recommended tightening torque for set screw	75 Nm
Designation of housing	C322-
Designation of bearing	UC322G2



NTN Bearing Driveshaft do Brasil